



Designed to be the most adaptable switch on the market, the 69J offers the user the flexibility to build the pressure switch around the compressor—not the other way around. The unloader can be mounted on the front or either side, and can be rotated to any of eight different positions allowing for quicker assembly and shorter tubing. Bottom cable entry is also available with unique built-in clamping strain relief for even quicker assembly. With thousands of variations right off the production line, the 69J provides maximum flexibility at minimum cost. With UL, CSA and CE approvals, the 69J is designed to be sold anywhere in the world.

Class 69J Switch

Standard Features Include:

- 3 and 5 HP 175 PSI maximum
- Improved unloader valve design
- Several terminal options
- Optional bottom cable entry
- Silver cad-oxide brazed contacts
- Rugged cover
- Various pipe locations
- Choice of auto-Off lever locations
- UL listed
- CSA certified
- CE approved
- 1/4" female NPT with pulsation orifice

69J Air Systems

Min. Close Cut-In	Max. Open Cut-Out	Differential Range	Pressure Setting Adjustment Table	Horsepower				Factory Setting	NEMA 1 General Purpose Cat No.
				1 Phase		3 Phase			
				120V	240V	240V	480/600V		
60 psi	110 psi	15-25 psi	R	1.5	2.0	3.0	—	80-100	69JF6
60 psi	110 psi	15-25 psi	R	2.0	3.0	5.0	1.0	80-100	69JG6
50 psi	135 psi	25-33 psi	S	1.5	2.0	3.0	—	95-125	69JF7
50 psi	135 psi	25-33 psi	S	2.0	3.0	5.0	1.0	95-125	69JG7
90 psi	165 psi	25-38 psi	T	1.5	2.0	3.0	—	115-150	69JF8
90 psi	165 psi	25-38 psi	T	2.0	3.0	5.0	1.0	115-150	69JG8
100 psi	175 psi	30-40 psi	U	1.5	2.0	3.0	—	140-175	69JF9
100 psi	175 psi	30-40 psi	U	2.0	3.0	5.0	1.0	140-175	69JG9

PSI Table R

Cut-In-C		Cut-Out A
Min.	Max.	
60	70	85
65	75	90
70	80	95
75	85	100
80	90	105
85	95	110

PSI Table S

Cut-In-C		Cut-Out A
Min.	Max.	
52	60	85
62	70	95
72	80	105
82	90	115
92	100	125
102	110	135
112	120	145

PSI Table T

Cut-In-C		Cut-Out A
Min.	Max.	
89	96	125
94	101	130
99	106	135
104	111	140
109	116	140
114	121	150
119	126	155
124	131	160
129	136	165

PSI Table U

Cut-In-C		Cut-Out A
Min.	Max.	
100	110	140
105	115	145
110	120	150
115	125	155
120	130	160
125	135	165
130	140	170
135	145	175

Electrical Ratings

Cat. No.	Control Circuit	Horsepower				
		1 Phase		3Phase		DC
		112V	240V	240V	480-600V	
69JF	A600	1.5	2.0	3.0	—	1/4
69JG	A600	2.0	3.0	5.0	1	1/2

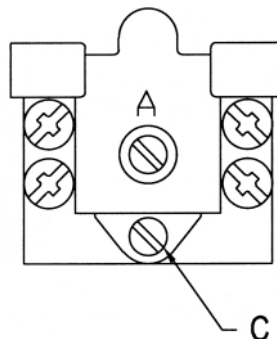

Pressure Adjustment Settings

Screw A—Turn clockwise to increase and counter-clockwise to decrease pressure range (both cut-in and cut-out).

Differential Adjustment

Screw C—Turn clockwise to increase and counter-clockwise to decrease cut-in pressure.

NOTE: Differentials shown on tables above are averages only.

69J Modifications

Description	Cat. No. Suffix (add suffixes in order shown)	Minimums
Auto-off disconnect lever	L	
Unloader valve	Y	
1/4" quick connects (load terminal only)	A	24 pc min
Two grommets for 1/2" conduit hole	G	
Pipe Fittings:		
1/4" male NPT	2A	24 pc min
Four port manifold (each port is 1/4" NPT)	2C	24 pc min
3/8" female NPT	2J	24 pc min
Special pressure settings: Suffix Z is followed by setting Example: 69JF7LYZ90120	Z†	24 pc min

† See Instruction Sheet included with switch for manual adjusting instructions.

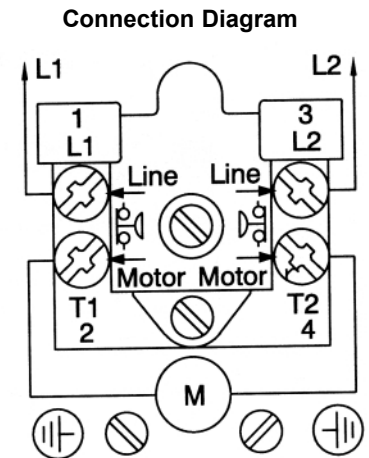
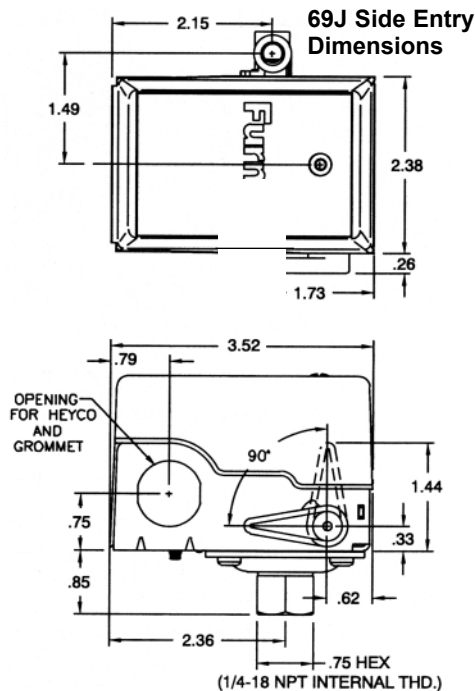
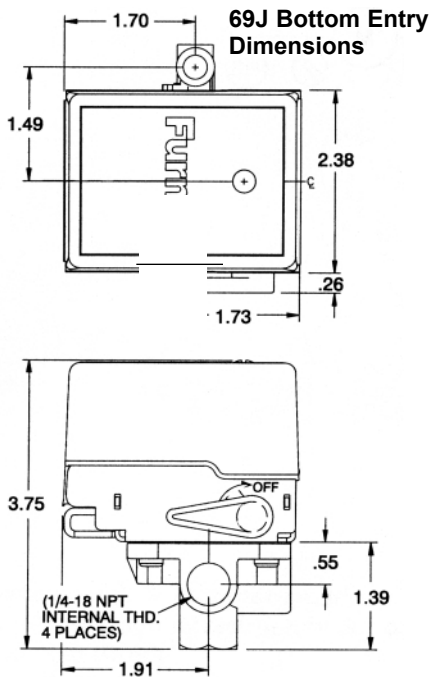

Replacement Parts

Description	Cat. No.
Unloader valve	69DJA
Grommets for 1/2" conduit hole	D00492001

